

A
COMPLETE
LINE OF
STOCK
AND
CUSTOM
STENCILS

AMERICAN STENCIL, LLC

11 Holt Drive, Ste 111

Stony Point, NY 10980

Phone: 201-251-6460 • Fax: 201-251-6463

amstencil@yahoo.com

www.americanstencil.com

www.americanstencil.net

WE ACCEPT:



Thank you for your interest in our Poly Vinyl stencils. The following pages contain information and prices on over 300 standard ready to ship items. Materials used for all of our stencils are 100% virgin polymers with thicknesses of 1/8" and 1/16" gauge to withstand heavy use. Our stencils are all designed to meet D.O.T. specs nationwide. Layout and designs follow through to the smallest stencil, allowing you to create more visible and proportioned markings. All stencils are cut with ample overspray and are designed for a quality job. Our stencils are easy to transport, lighter than wood or metal and clean up easily. When paint dries, it easily peels from polymer.

We have designed patterns and legends to suit your every need in pavement marking. In addition, our stencils are designed for many other types of applications. Some of the many uses for our stencils are as follows:

- Industrial Floor Marking
- Wall Legends
- Machinery Labeling
- Factory Safety Awareness
- Athletic Fields
- Running Tracks
- Airports
- Logos

All of our stencils roll up easily for quick UPS shipping. Just order by item number or call us for a quote on any custom stencil you may need.

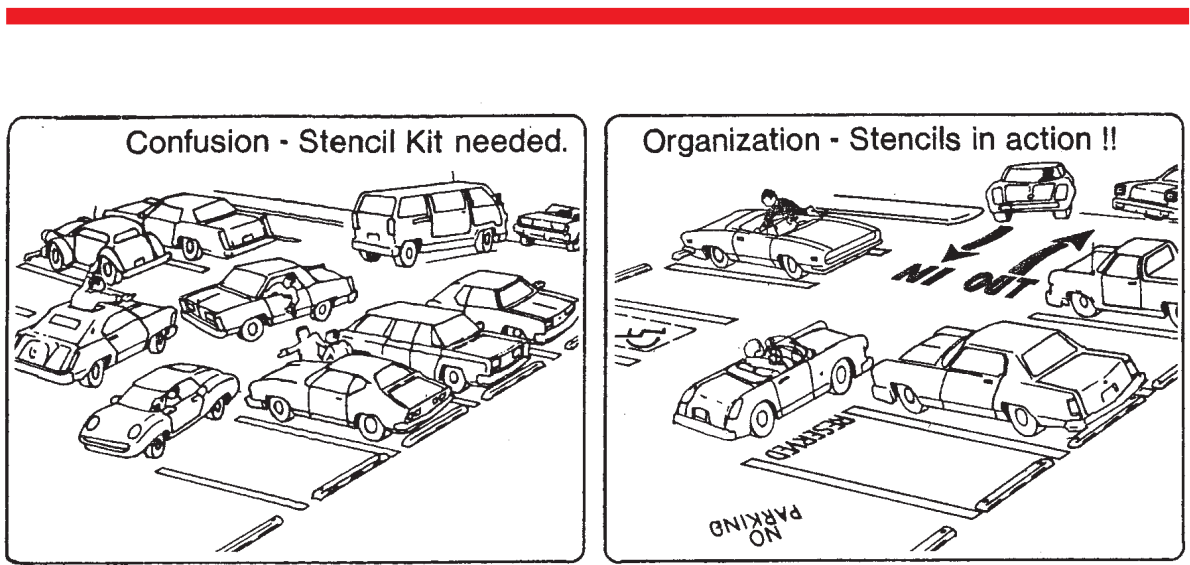

SAFETY FLOOR MARKING STENCILS

Poly-Vinyl Stencil SAFETY STENCILS

- LARGE 22" DIAMETER
- WORDS & GRAPHICS
- KEEP EMPLOYEES ALERT

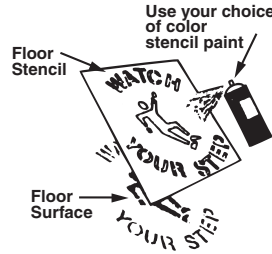

- Provide a permanent safety awareness message for employees
- Constructed of durable plastic for use over and over again

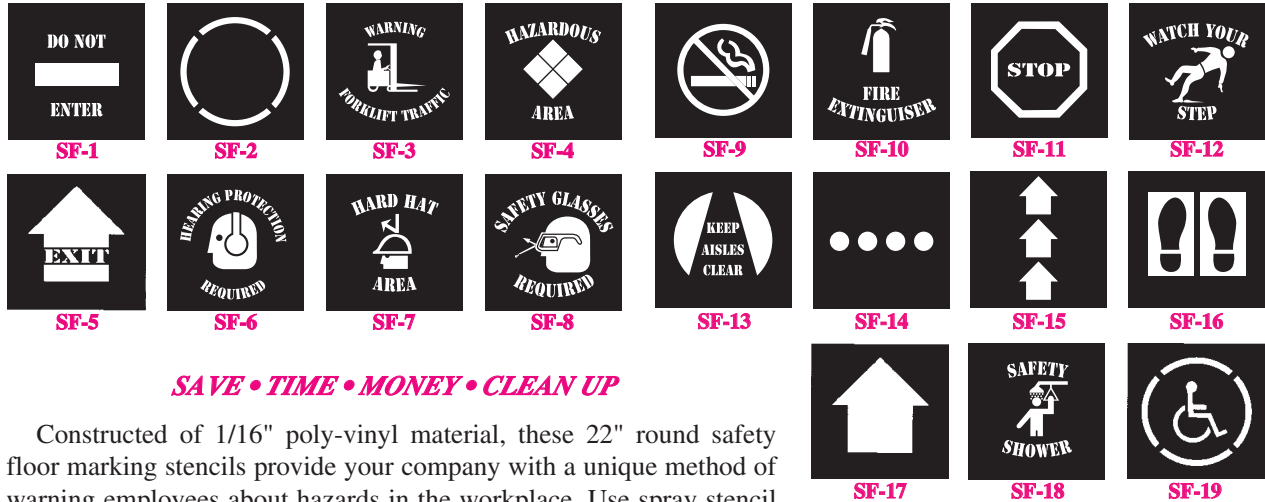

SAVE • TIME • MONEY • CLEAN UP

Constructed of 1/16" poly-vinyl material, these 22" round safety floor marking stencils provide your company with a unique method of warning employees about hazards in the workplace. Use spray stencil paint and permanently apply messages on floor, walls, or wherever you feel a warning is necessary. Just place the safety marking stencils on the area that you would like to apply the message—and paint!

ITEM #10

ENVIRONMENTAL

- Bay
- River
- Lake

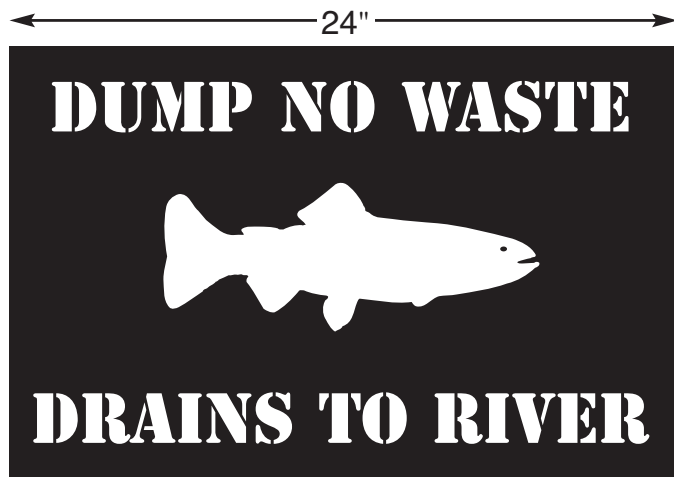

- Pond
- Ocean
- Stream

- Creek
- Wetlands

ITEM #119C
Three Piece Universal Arrow Set

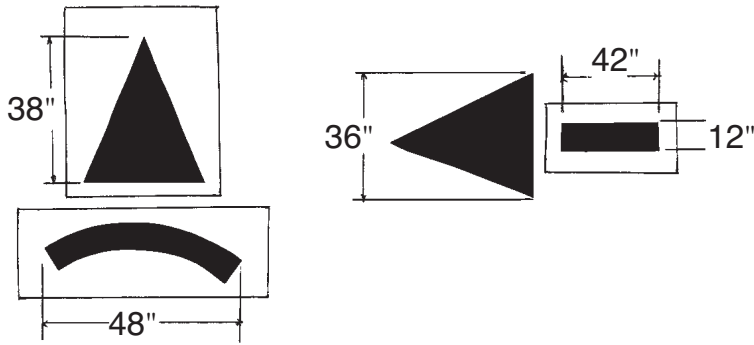

ITEM #119F
6' 1 pc. arrow

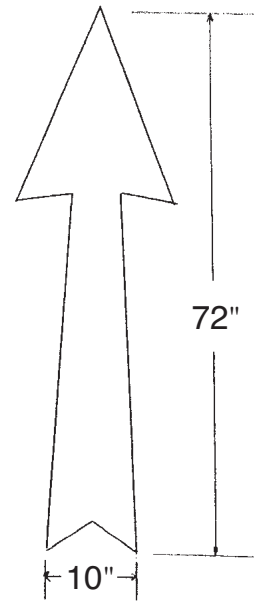

ITEM #119D

ITEM #119E

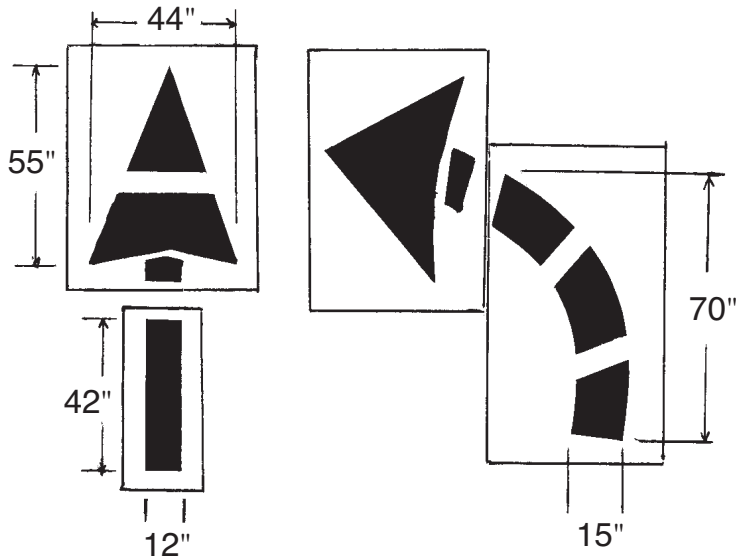

ITEM #119G
6' 1 pc. arrow combination

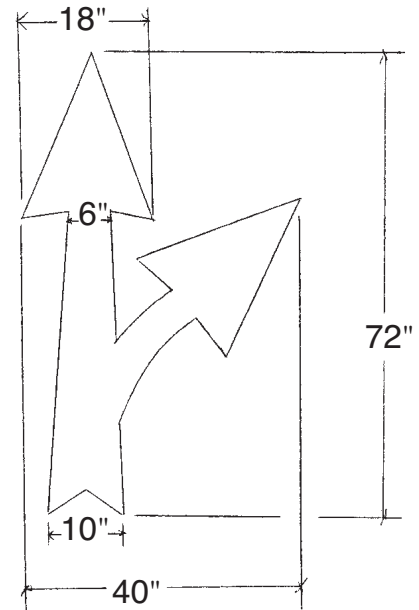

ARROW #112B
Three Piece Set

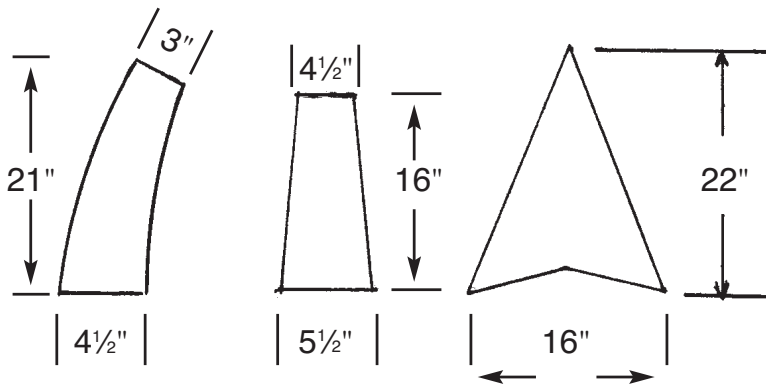

FEDERAL SPEC. ARROWS

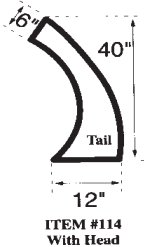
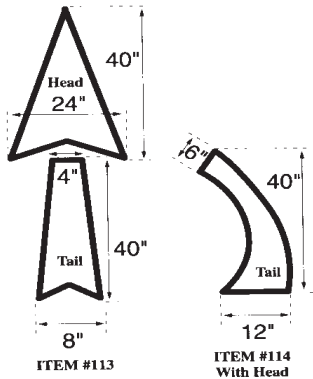
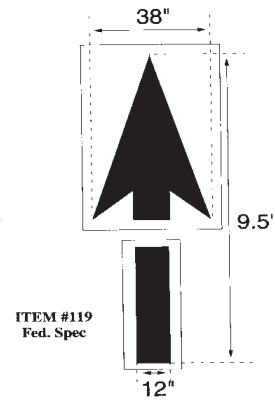
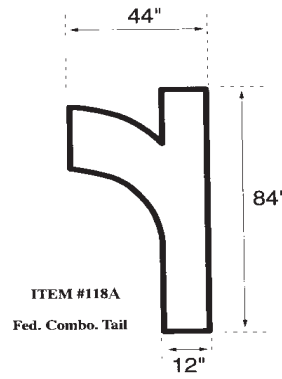
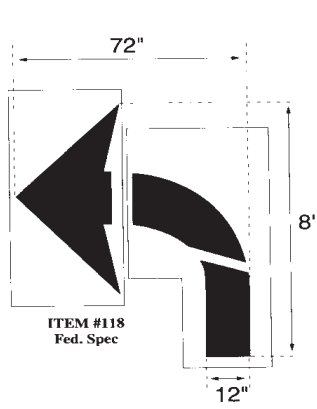

All Three Pieces
ITEM #115

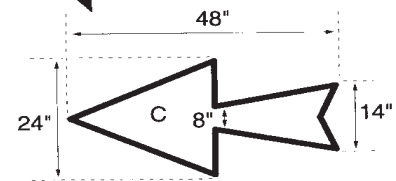
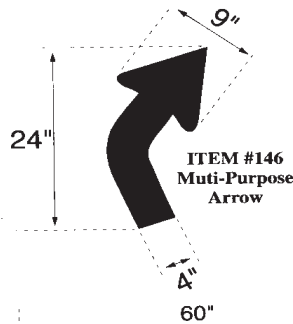
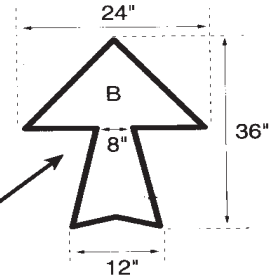
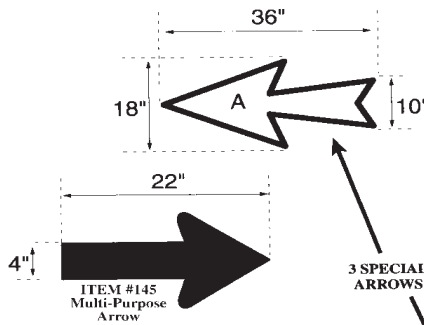

Also Available - Curve Arrow
to match #C

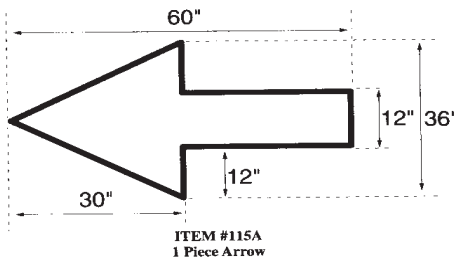
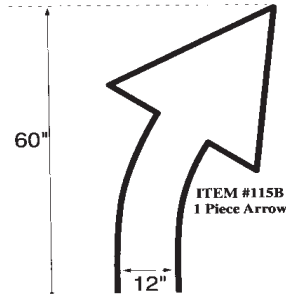

24"x72" & 36"x72"



Crosswalk Bar
ITEM #230

4"x144"



Line Stencil
ITEM #231



California Loop
ITEM #232



Wheel Stop Overspray
ITEM #233



ITEMS #234/235/236/237

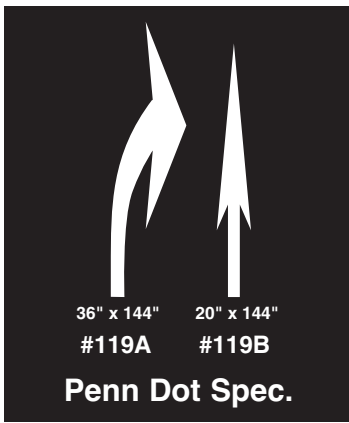

ITEMS #119A & 119B



ITEM #215

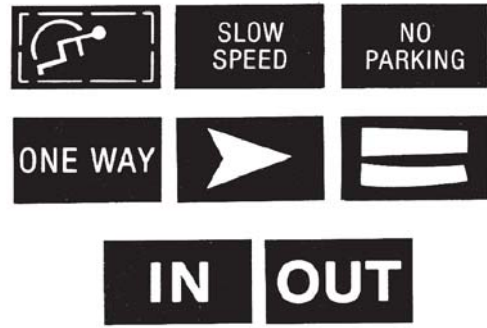

1 set 8" 0 to 9 & 1 set 8" A to Z

ITEM #238

*1/16" Poly

Outline Arrows

LEAVES A 4" WIDE OUTLINED ARROW

ITEM #119H

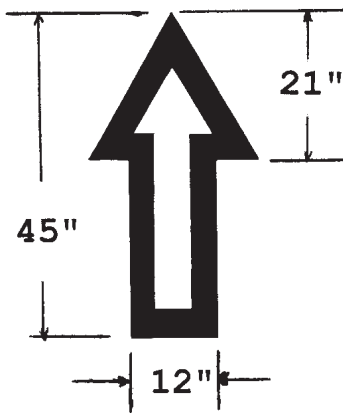

ITEM #119I

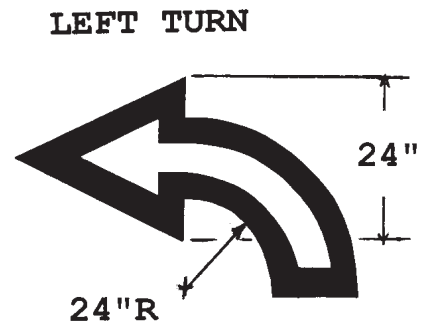
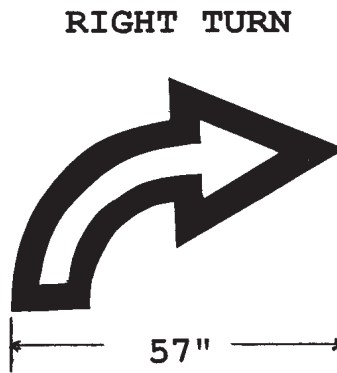

3 Pc. Arrow Kit

36" WIDE x 90" HIGH

ITEM #119J

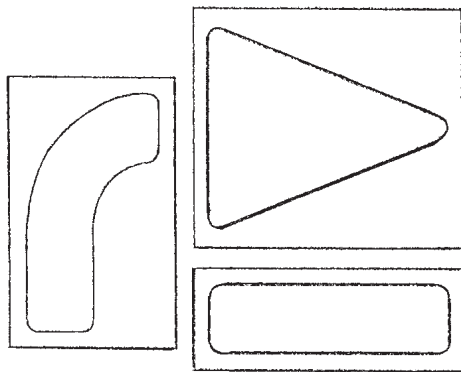

2 Pc. Arrow Kit

20" WIDE x 42" HIGH

ITEM #119K

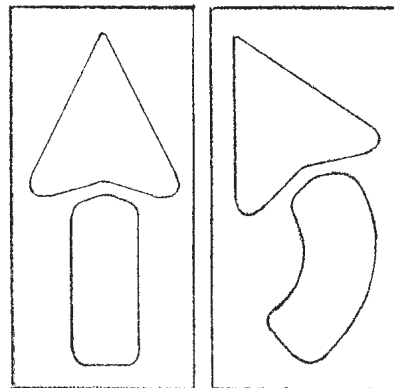

We make your job easier.

PARKING LOT ARROWS

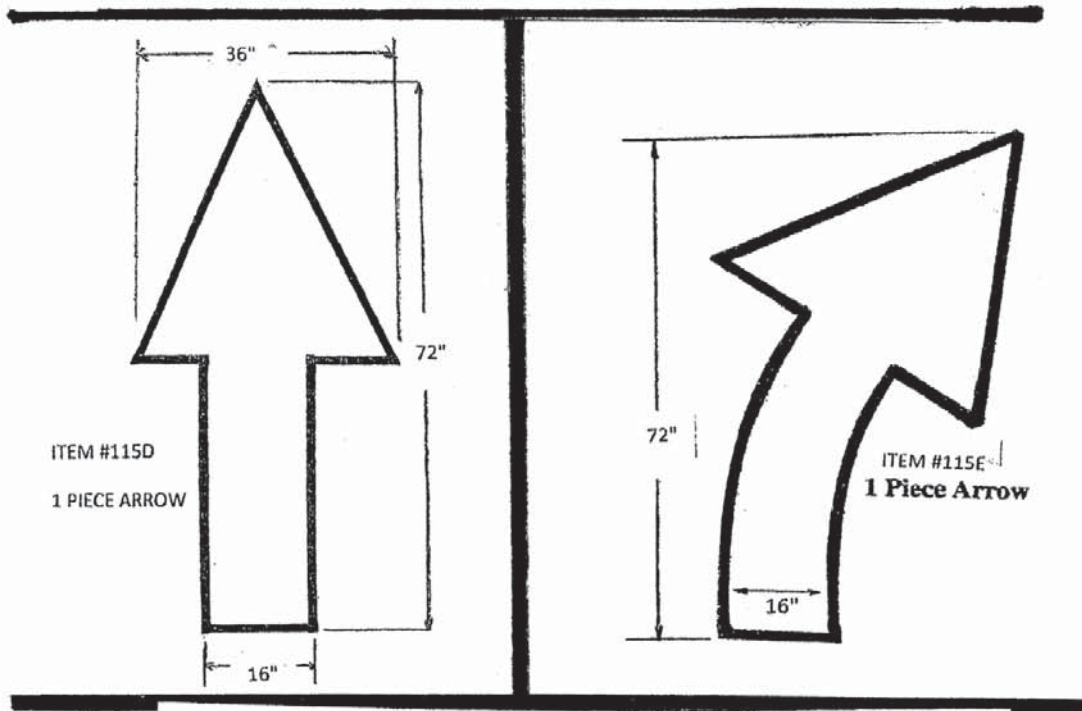

DOT BIKE LANE ARROW

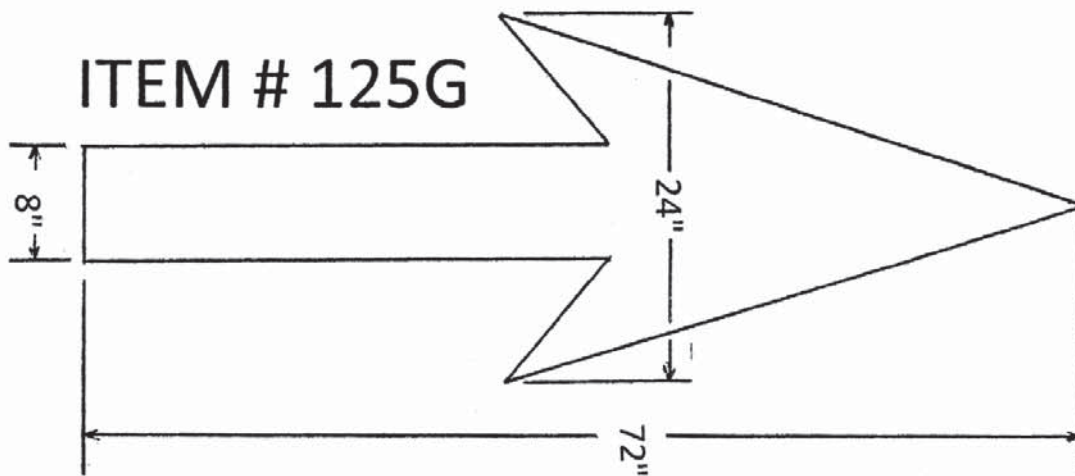

AMERICAN STENCIL, LLC
11 Holt Dr., Ste 111
Stony Point, NY 10980
Phone: 201-251-6460 • Fax: 201-251-6463
amstencil@yahoo.com

www.americanstencil.com
www.americanstencil.net

Custom Stencils Manufactured to your Specifications.

If you don't see it – ask for it!

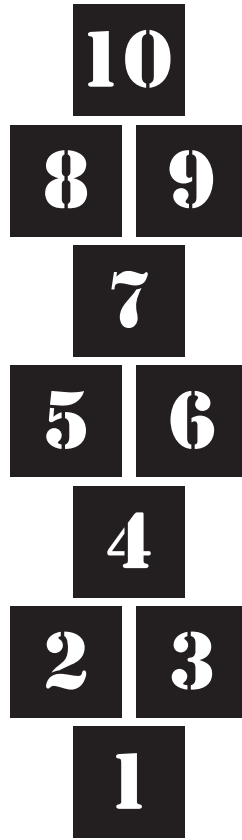
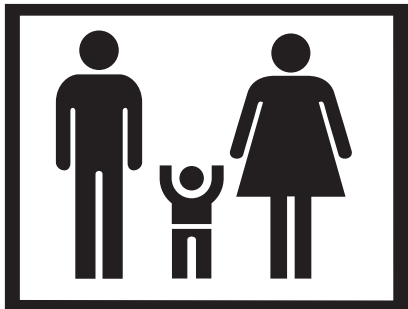

ITEM #125C

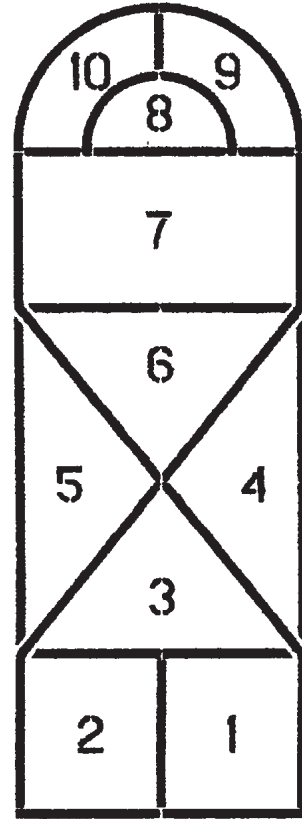

ITEM #125E



ITEM #216

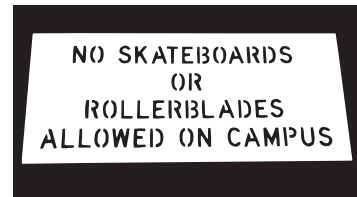

Easy to Use One-Piece Stencils

BABY & CARRIAGE

32"W x 36"H



ITEM #215B

BABY & STORK

45"W x 24"H



ITEM #215A

GOLF CART

36"W x 28"H



ITEM #214A

ROLLER BLADING IN-LINE SKATING

16"W x 20"H



ITEM #214B

NO PARKING SYMBOL

26" DIAMETER



ITEM #239A

NO SKATEBOARDS

26" DIAMETER



ITEM #239B

Manufacturers of
Form - Flex[®]
 The original poly-vinyl
 permanent marking stencil.

FULL LETTER & NUMBER KITS

ITEM NO.	ITEM DESCRIPTION
98-FA	4" Letters A-Z
99-FN	4" Numbers 0-9
100-FA	6" Letters A-Z
101-FN	6" Numbers 0-9
101A-FA	8" Letters A-Z
101B-FN	8" Numbers 0-9
102-FN	10" Numbers 0-9
102A-FA	10" Letters A-Z
103-FN	12" Numbers 0-9
104-FA	12" Letters A-Z
104B-FN	18" Numbers 0-9
104A-FA	18" Letters A-Z
105-FN	24" Numbers 0-9
106-FA	24" Letters A-Z
107-FA	36" Letters A-Z
107A-FN	36" Numbers 0-9
108A-FA	48" Letters A-Z
108-FN	48" Numbers 0-9
109FA	72" Letters A-Z
109A-FN	72" Numbers 0-9
110A-FA	96" Letters A-Z
110C-FN	96" Numbers 0-9

FEDERAL LANE REDUCTION ARROW

18' LONG x 5'6" WIDE

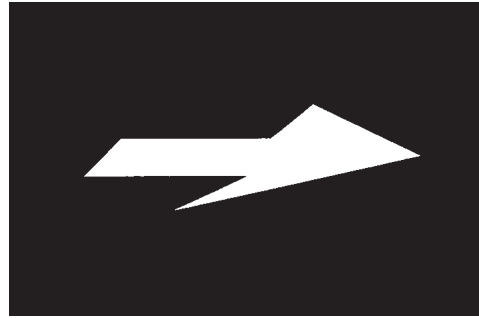

ITEM #119M

FEDERAL U-TURN ARROW

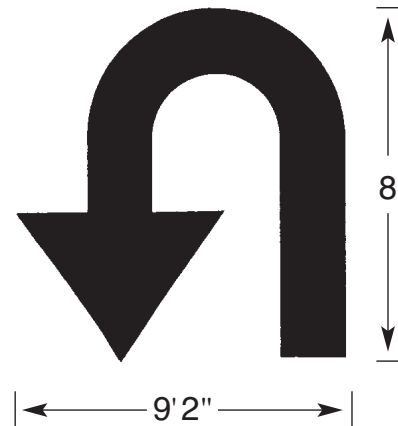

ITEM #119L

3 PIECE ARROW KIT

37" Straight Arrow 43" Curve Arrow

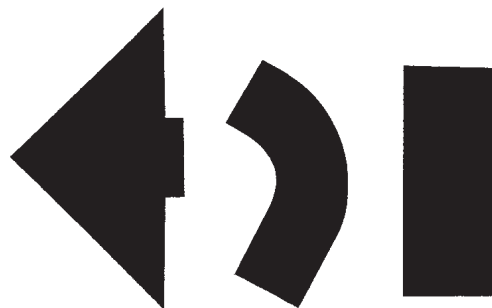

ITEM #115C

Railroad

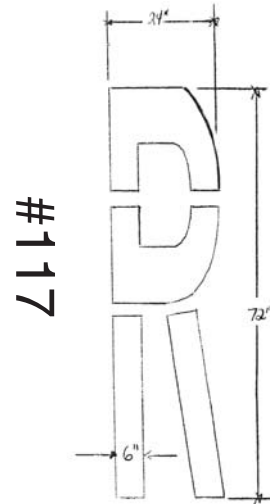
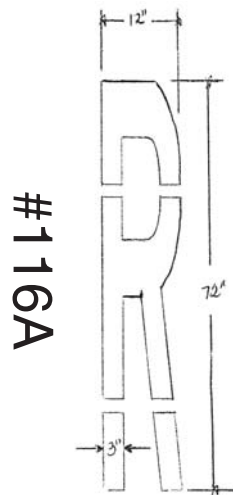
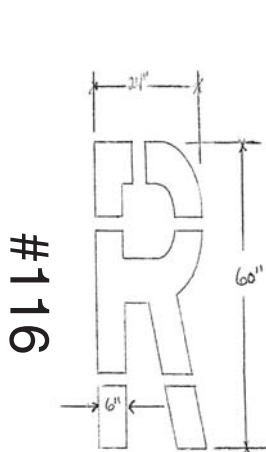

Yield Line

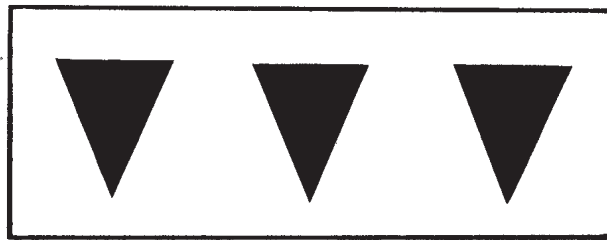

AVAILABLE SIZES

12"x18"

16"x24"

24"x36"

ITEM #215C

SPECIFY SIZE

(3 images on 1 stencil)

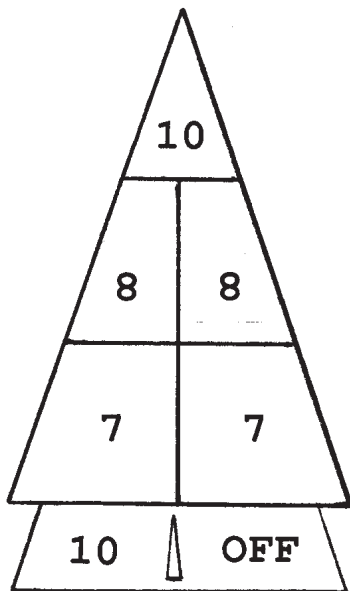

Shuffle Board

6'x10'x6"

ITEM #152C



21 Pc. Kit

ITEM #242

KIT INCLUDES:

8" VISITOR RESERVED
0 - 9

9" NO PARKING
SLOW SPEED
ONE WAY

18" STOP
IN
OUT

HANDICAP SYMBOL
w/BORDER

3 PC. ARROW KIT

*1/16" Poly

ITEM NO.	DESCRIPTION
10	Floor Marking Stencils SF-1 thru SF-19 (1/16" Poly) (page 3)
98	4" Letters
99	4" Numbers
100	6" Letters
101	6" Numbers
101A	8" Letters
101B	8" Numbers
102	10" Numbers
102A	10" Letters
103	12" Numbers
104	12" Letters
104A	18" Letters
104B	18" Numbers
105	24" Numbers
106	24" Letters
107	36" Letters
107A	36" Numbers
108	48" Numbers
108A	48" Letters
108B	48" x 10" Wide Letters "B, I, K, E, L, A, N, E, O, N, L, Y, X, -, I, N, G" any single letter or combination of
109	72" Letters
109A	72" Numbers
110	96" Letters(6" Stroke)
110A	96" Letters(4" Stroke)
110B	96" Numbers(6" Stroke)
110C	96" Numbers(4" Stroke)
111	Handicap Symbol H 32" x W 24" x 2" Stroke
111A	Handicap Symbol H 41" x W 33" x 2 1/2" Stroke
111B	Box for Handicap Symbols 40" x 45"
111C	Handicap Symbol H 42" x W 36" x 3 1/2" Stroke
111D	Handicap Symbol H 24 1/2" x W 22"
111E	Active Handicap Symbol H 45" x W 36"
111F	Active Handicap Symbol H 36" x W 28"
112	Handicap Symbol 12" x 18" x 1 1/4" Stroke
112A	Handicap Symbol W/Border 20" x 32"
112B	22" Combination 3 pc. Arrow Kit (page 18)
ArrowA	Straight or Curve 36" (page 19)
ArrowB	Straight or Curve 36" (page 19)
ArrowC	Straight or Curve 48" (page 19)
113	6' Straight Arrow(2 pc.) (see illust page 19)
114	6' Curved Arrow(2 pc.) (see illust page 19)
115	6' Arrow W/Curved & Straight Tails (3 pcs.) (page 19)
115A	5' Straight Arrow(1 pc.) (see illust. page 19)
115B	5' Curved Arrow(1 pc.) (see illust. page 19)
115C	3 pc. Arrow Kit (page 18)
115D	6' Straight Arrow(1 pc.)
115E	6' Curved Arrow(1 pc.)
116	5" "R" for Railroad Xing 2' x 5' x 6" Stroke
116A	6' Federal "R" for Railroad 1' x 6' x 3" Stroke
116B	6' 6" "R" for Railroad • Penn DOT Special
117	6' "R" for Railroad Xing 2' x 6' x 6" Stroke



123A



123B



124



124A



125



125A



125B/126



125D



126A



126B



126C



117A



117B



117B

ITEM NO.	DESCRIPTION
117A	"X" for Railroad Xing
117B	"X" for Railroad Xing • Penn DOT Special
118	Federal Curve Arrow(see illust. page 19)
118A	Federal Combo Tail(see illust. page 19)
119	Federal Straight Arrow(see illust. page 19)
119A	Penn DOT Curved Arrow(see illust. page 17)
119B	Penn DOT Straight Arrow(see illust. page 17)
119C	3 Pc. Large Arrow Kit (page 18)
119D	Straight Arrow(page 18)
119E	Curve Arrow(page 18)
119F	Straight Arrow(page 18)
119G	Curve & Straight Arrow Combination (page 18)
119H	Straight Outline Arrow(page 17)
119I	Curved Outline Arrow(page 17)
119J	3 pc. Large Arrow Kit(page 17)
119K	Set Straight & Curved Arrows(page 17)
119L	Fed U-Turn Arrow(page 16)
119M	Lane Reduction Arrow(page 16)
120	8' x 16" Stop Bar
120A	8' x 24" Stop Bar
121	8' x 12" Stop Bar
122	8' x 6" Stop Bar
123	8' x 4" Stop Bar
123A	Barricade Stripe 6" x 72"(page 12)
123B	Bicycle Loop 17" x 43"(page 12)
124	Fire Hydrant Symbol W/Arrow 18" x 33"(pg 12)
124A	Child Running 25" x 48"(page 12)
124B	Bike Lane Symbol 17" x 33"
125	Maltese Cross Symbol 37" x 37"(page 12)
125A	Pedestrian Crossing Symbol 36" x 60"(pg 12)
125B	Bike Lane Symbol 24" x 48"(page 12)
125C*	Hopscotch Board W/Numbers 96" x 24" (see illust. page 6)
125D	Bike Lane Symbol W/Arrow(page 12)
125E*	Hopscotch Board W/Numbers 36" x 104"
125F	40" x 72" Bike Lane Symbol w/Helmet
125G	Dot Bike Arrow
126	Bike Lane Symbol 40" x 60" w/Helmet
126A	Bike Trail Symbol 65" x 40"(page 12)
126B	"No Bicycle" Symbol 42" Diameter(page 12)
126C	Bicycle Diamond 36" x 72"(page 12)
126D	10" SENIOR
127	10" MANAGER
127A	10" HANDICAP
128	10" LOADING
128A	10" CUSTOMER
129	10" STAND
130	10" ASST
131	10" CHIEF
1331A	10" STOP
132	10" FIRE
133	10" LANE
134	10" ZONE
135	10" TAXI
136	10" MGR

* 1/16" Poly Material

AMERICAN STENCIL

TEL: 201-251-6460 • FAX: 201-251-6463

ITEM NO.	DESCRIPTION
137	10" DOCTOR
138	10" PRESIDENT
139	10" RESERVED (page 8)
139A	10" RESERVED
139B	10" PARKING
140	10" VICE
140A	10" ONLY
141	10" VISITOR
141A	10" COMPACT
141B	10" CARS
141C	6" PARKING
141D	6" ONLY
142	6" NO PARKING
142A	6" COMPACT
142B	10" 1 pc. ONE WAY (page 8)
143	10" NO PARKING
144	6" HANDICAP
145	Multi-Purpose Arrow (Straight 22") (see illust. page 19)
146	Multi-Purpose Arrow (Curved 24") (see illust. page 19)
146B	6" 1 pc. STOP-LOOK (page 8)
147	6" No Skateboarding
148	6" NO DIVING
148A	6" NO RUNNING
149	6" VISITOR
150	6" EXIT
150A	6" ACCESSIBLE
150B	6" VAN
151	6" NO SMOKING
151A	6" RESERVED
151B	Football Yard Marker
152	Football Field Kit 36" Roman Style 0, 1, 2, 3, 4, 5, G, >
152A	Football Field Kit 72" Roman Style 0, 1, 2, 3, 4, 5, G, >
152B	Running Track Kit 36" Numbers 1-8 & Markers
152C	Shuffle Board Kit Includes numbers set & word OFF (page 11) (1/16" Poly)
153	12" NO
154	12" PARKING
155	12" FIRE
156	12" LANE
157	12" ZONE
157A	12" COMPACT
157B	12" LOADING
157C	12" STOP
157D	12" THRU
157E	12" DRIVE
158	12" RESERVED
158A	12" CUSTOMER
159	12" VISITOR
159A	12" DO
159B	12" NOT
160	12" ENTER
161	12" EXIT

ONLY
SCHOOL
XING
STOP



152, 152A

ITEM NO.	DESCRIPTION
162	12" ONLY
162A	4" No Skateboarding
162B	4" NO DIVING
162C	4" NO RUNNING
162D	4" No Roller Blading
163	4" NO PARKING
163A	4" CUSTOMER
163B	4" ONLY
163C	4" PARKING
163D	4" COMPACT
163E	4" RESIDENT
163 F	4" GUEST
164	4" RESERVED
165	4" VISITOR
166	4" FIRE
167	4" LANE
167A	4" LOADING
167B	4" 1 pc. WAIT FOR WALK SIGNAL (page 8)
168	4" ZONE
168A	4" MIN.
168B	4" MANAGER
168C	4" HANDICAP
169	4" SENIOR
170	4" MANAGER
170A	8" CUSTOMER
171	8" LOADING
171A	8" ONLY
172	8" STAND
173	8" ASST
174	8" CHIEF
175	8" FIRE
176	8" LANE
177	8" ZONE
178	8" TAXI
179	8" MGR
180	8" DOCTOR
181	8" PRESIDENT
182	8" RESERVED
183	8" VICE
184	8" VISITOR
185	8" COMPACT
186	8" CARS
187	8" NO PARKING
187A	8" PARKING
188	8" HANDICAP
188A	9" 1 pc. SLOW SPEED (page 8)
188B	9" 1c. NO PARKING (page 8)
189	18" NO
190	18" PARKING
191	18" FIRE
192	18" ZONE
193	18" LANE
194	18" ONLY
195	18" ONE
196	18" WAY
196A	18" DO
196B	18" NOT

* 1/16" Poly Material





ITEM NO.	DESCRIPTION	ITEM NO.	DESCRIPTION
197	18" DRIVE	232	California Loops(page 19) Any Size
198	18" THRU	233	Wheel Stop Overspray Kit(page 19)
198A	18" EXIT	234*	Recycle Symbol(1/16" Poly) (page 19) 12" - 16" - 18"
198B	18" ENTER	235*	Recycle Kit 5 pcs. 2" letters(1/16" Poly)
198C	18" STOP	236*	Recycle Kit 5 pcs. 4" letters(1/16" Poly)
198D	18" IN	237*	Recycle Kit 5 pcs. 6" letters(1/16" Poly)
198E	18" OUT	238*	Giant Economy Starter Kit(1/16" Poly)(page 7) 1 set 8" (0-9) • 1 set 8" (A-Z) • 1 ea Reserved ADA Symbol 1 ea 9" (Slow Speed/No Parking) 1 ea 10" One Way 1 ea 19" In/Out • 1 ea Arrowhead 1 ea Curve/Straight Tail
199	24" NO	239*	Wheel Stop Stencils 2 3/4" Letters (specify legend)(1/16" Poly) (page 8)
200	24" PARKING	239A*	No Parking Symbol(1/16" Poly) (page 15)
200A	24" DO	239B*	No Skate Boards(1/16" Poly) (page 15)
200B	24" NOT	240*	Fuel Identification Stencils (specify legend) (1/16" Poly) (page 8)
201	24" FIRE	241*	Parks & Recreation Stencils (specify legend) (1/16" Poly) (page 8)
202	24" LANE	242*	21 pc. Stencil Kit (as per list) (1/16" Poly) (page 11)
203	24" ZONE	243*	Economy Kit(1/16" Poly) (page 10)
204	24" ENTER	244	Enter-Exit-First Aid Arrows(page 9)
205	24" EXIT	245*	Trash Receptical Symbol(1/16" Poly) (page 10)
206	24" DRIVE	246*	No Roller Blading Symbol(1/16" Poly) (page 10)
207	24" THRU	247	Shared Bicycle Lane(page 10)
208	24" LOADING	248*	Cycling Awareness Symbol(1/16" Poly)(pg.10)
209	24" ONE	249	Speed Hump 72" x 72"(2 pc.)(1/8")
210	24" WAY	250	Electric Charging Station & Parking Stalls 40" x 35" (2 pc.)(1/8") 2-Color
210A	24" STOP	251	Electric Charging Station & Parking Stalls 43" x 44" (1 pc.)(1/8")
210B	24" ONLY	252	Clean In/Clean Out 60" x 60" Wording Incl. (2 pc.)(1/8")
210C	24" SLOW	253	Military Style Legends Letters 60"(1/8")
210D	24" AHEAD	254	Military Style Legends Letters 96"(1/8")
211	6" LOADING	255	Recycle Symbol 36" Dia.(1pc.)(1/8")
212	6" ZONE	256	No Smoking Symbol 36" Dia.(pc.)(1/8")
213	6" LANE	257	Sewer Grate 24" x 36"(1/8")
214	6" FIRE	258	Alternative Parking Stall 46" Dia.(1/8")
214A	GOLF CART (page 15)	259	Compact Car 36" x 30"(1/8")
214B	ROLLERBLADE (page 15)	260*	Motorcycle Parking 36" x 25"(1 pc.)(1/16")
215*	Pool Kit – includes seven (7) one-piece Legends, 4" Number Set, and four (4) 9" Symbols (page 17) (1/16" Poly)	261	Electric Charging Station Parking Stalls 45" Diameter(1 pc.)(1/16")
215A	Stork Symbol(page 15)	262	Walk Bike 18" x 18"(1/16")
215B	Baby Carriage Symbol(page 15)	263	No Pedestrian 42" Dia(1pc.)(1/16")
215C	Yield Lines (specify size) (page 11) 12" x 18" - 16" x 24" - 24" x 36"	264	Electric Charging Station Parking Stalls 36" x 48" (1 pc.)(1/8")
216	Buckle Up! – includes symbol 96" x 28" and legend(page 6) 96" x 10"	265	Low-emitting & Fuel Efficient Vehicles 48" x 24" Diameter(1 pc.)(1/8")
217	48" 1 pc. NO(pages 20-21)	266	Compact Car Parking 36" x 48"(1 pc.)(1/8")
217A	48" 1 pc. LANE (pages 20-21)	267	McDonald's "THANK" 79" x 34"(1/16" or 1/8")
217B	48" 2 pc. AHEAD(pages 20-21) 2 Piece	268	McDonald's "YOU" 46" x 34"(1/16" or 1/8")
218	48" 1 pc. SLOW (pages 20-21)	269	McDonald's "DRIVE" 71" x 34"(1/16" or 1/8")
219	48" 1 pc. YIELD (pages 20-21) 2 Piece	270	McDonald's "THRU" 71" x 34"(1/16" or 1/8")
220	48" 1 pc. STOP (pages 20-21)	271	Walmart ADA Symbol 84" x 72"(2pc.)(1/8")
221	48" 1 pc. EXIT (pages 20-21)	272	McDonald's Arch 84" x 78"(1/8")
222	48" 1 pc. DRIVE (pages 20-21) 2 Piece	273	McDonald's 3 pc. Set 42" Dia. Circle and (2x) 29 1/2" x 29 1/2" Arrows(1/8")
223	48" 1 pc. DO(pages 20-21)	274	Tic Tac Toe Layout 12" x 12" Boxes with (4x) "X" and (4x) "O" (1/8")
224	48" 1 pc. THRU (pages 20-21) 2 Piece		
225	48" 1 pc. NOT(pages 20-21)		
226	48" 1 pc. ONLY (pages 20-21)		
227A	48" 1 pc. ENTER (pages 20-21) 2 Piece		
227B	ADA Symbol W/No Parking(page 22)		
228	ADA Symbol W/Van Accessible(page 22)		
229	ADA Symbol W/Handicap Parking(page 22)		
230	Crosswalk Bars (page 19) 24" x 72"		
231	Line Stencil(page 19) 4" x 144"		

* 1/16" Poly Material

We make your job easier.

AMERICAN STENCIL

TEL: 201-251-6460 • FAX: 201-251-6463

ITEM NO.	DESCRIPTION
275	Leaf w/Roadway 36" x 55" Low Emitting Fuels
276	Double Leaf 40" x 40" Low Emitting Fuels
277	60" S-T-O-P
278	3" 1pc., Stencils, 1/16" Poly NO, PARKING, FIRE, LANE, RESERVED, VISITOR, HANDICAPPED, HOUR, ALL, RATED, WALL, FOR, PLUS, NO EXIT, TOW, ZONE, ONLY, AWAY, PREMIUM, OPENING, KEROSENE, PERMIT, REGULAR
279	Circles for Playgrounds Available sizes 4" to 24" diameter 30" X & 30" ▲ (Also used for aerial surveys)
280	Crosswalk Awareness Symbol Available sizes 12" & 16" letters LOOK!
281	Electric Car or Parking Stalls 42" Diameter 
282	Ribbon 72" 
283	Charging Station or Parking Stalls 40" x 35" 
284	* Roman Gothic 9" 0 to 9 set 
	* Roman Gothic 9" Letters A to Z
285	Handicap Symbol w/Border 1 piece 3" Wide Border 42" Sq. 
286	36" Letters 1Pc. Stencils

AMERICAN STENCIL, INC.
479 S. Broad Street
Glen Rock, NJ 07452
Phone: 201-251-6460 • Fax: 201-251-6463
Amstencil@yahoo.com

 111E & F	 249	 2 - Color 250
 251	 252	STOP 253
STOP 254	 255	 256
 257	 258	 259
 260	 261	 262
 263	 264	 265
 266	THANK 267	YOU 268
DRIVE 269	THRU 270	 271
 272	 273	
 274	 275	 276

* 1/16" Poly Material

Office Hours
9:00 AM to 4:00 PM
Monday - Thursday

Easy to Use One-Piece Stencils

CLEAN UP! TRASH YOUR TRASH



ITEM #245
10"W x 12"H

NO ROLLER SKATING



ITEM #246
26" DIAMETER

BIKE SHARED LANE 2-PIECE STENCIL



ITEM #247
40"W x 111"H

BIKING AWARENESS



ITEM #248
20"W x 18"H

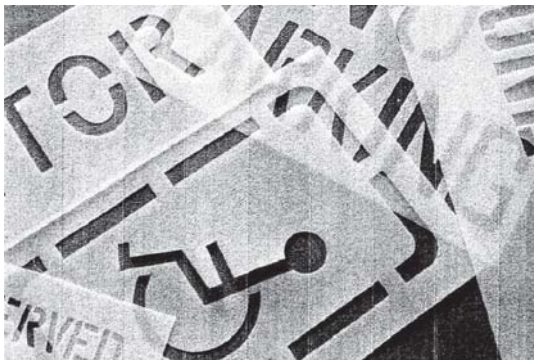

Stick to Your Budget and Get Every Stencil You Need

STOCK ECONOMY PLASTIC STENCIL KIT

Kit includes the following plastic stencils:

- 9" letters (A-Z), 9" numbers (0-9)
- Words in 9" letters: SLOW SPEED, NO PARKING
- Words in 10" letters: ONE WAY
- Words in 19" letters: IN, OUT
- 22" x 15" arrowhead; 20" arrow stems
- 31" x 19" Disabled Access Symbol

ITEM #243

* $\frac{1}{16}$ " Poly

BRASS INTERLOCKING STENCIL KITS

GOTHIC style

Horizontal Composition

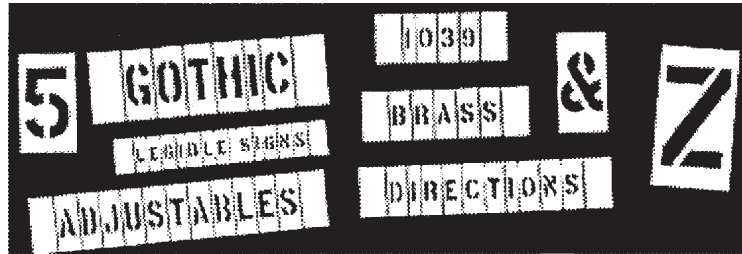

- Durable brass for long-lasting service.
- Clean with paint solvent.
- Quick, legible signs on all surfaces.
- Slide together and come apart easily.
- Use brush or spray ink, paint or use markers.

Numbers Only, Single Sets 15 Pieces As follows: 1234567890 1-Beginner, 1-Plain Ender 1-Dash, 1-Period	
Number	Size Description
10006	1/2"
10007	3/4"
10008	1"
10009	1-1/2"
10011	2"
10012	2-1/2"
10013	3"
10014	4"
10015	5"
10016	6"

Letters Only, Single Sets 33 Pieces As follows: ABCDEFGHIJKLMNPOQESTUVWXYZ& 1-Beginner, 1-Period Ender 1-Spacer, 1-Comma, 1-Dash, 1-Period	
Number	Size Description
10026	1/2"
10027	3/4"
10028	1"
10029	1-1/2"
10031	2"
10032	2-1/2"
10033	3"
10034	4"
10035	5"
10036	6"

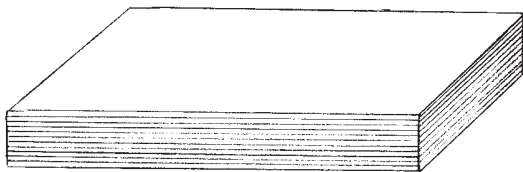

1/8" x 108" x 50"
1/8" x 156" x 50"
1/16" x 108" x 50"

AVAILABLE
SIZE

FOR THOSE ONE TIME JOBS OR SPECIALS DO IT YOURSELF!

Professional Results

with Minimal Investment

Ideal for:

- Rush Jobs
- Small Jobs
- Stenciling

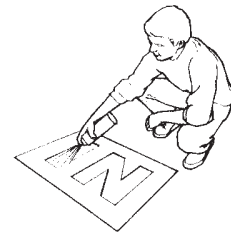

CALL FOR PRICING

AMERICAN STENCIL, LLC

11 Holt Dr., Ste 111
Stony Point, NY 10980

Phone: 201-251-6460 • Fax: 201-251-6463
amstencil@yahoo.com

Easy to Use One-Piece Stencils

9" HIGH LETTERS



ITEM #188A

9" HIGH LETTERS



ITEM #188B

4" HIGH LETTERS



ITEM #167B

6" HIGH LETTERS



ITEM #146B

10" HIGH LETTERS



ITEM #142B

Wheel Stop Stencils

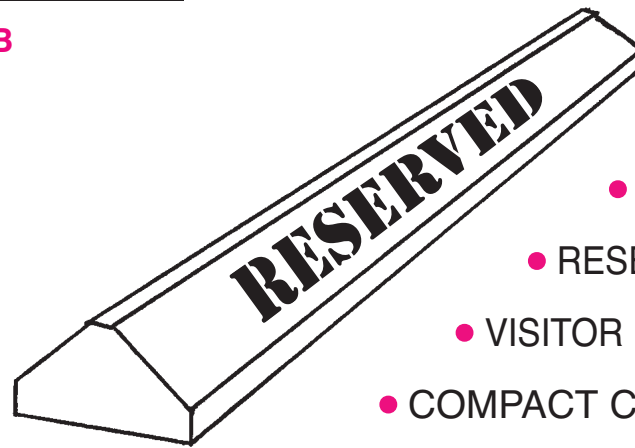

• 2¾" HIGH LETTERS

• HANDICAPPED

• RESERVED

ITEM #239

• VISITOR

• COMPACT CARS

*1/16" Poly

Fuel Identification/Environmental Stencils

ONE PIECE ALL 3" HIGH LETTERS

*1/16" Poly

VAPOR RECOVERY



REGULAR



KEROSENE



DIESEL

PREMIUM



PLUS

ITEM #240

Parks and Recreation Stencils

3" HIGH LETTERS

*1/16" Poly

RESERVED



VISITOR



NO PARKING



FIRE LANE

ONLY



HANDICAPPED

ITEM #241

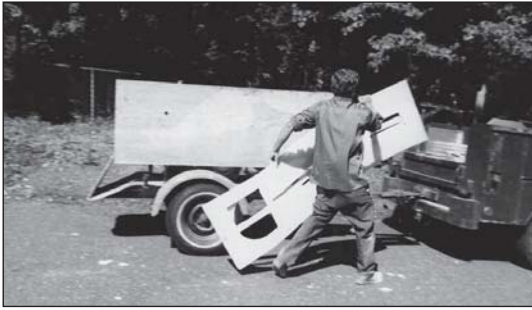

Easy to Transport • Light weight
Will not warp out of shape

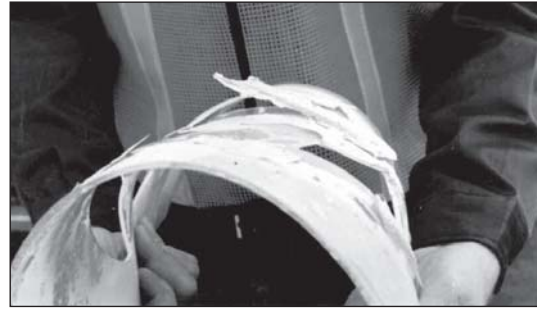

•Fast Easy Clean Up
•Paint Breaks & Falls Away by Flexing & Tapping a Hard Surface



New Products Every Month!
The Best Stencil for the Job

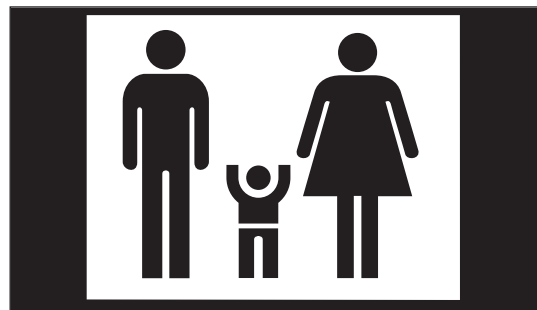

Unlike wood, aluminum, and other stencils,
they won't break, warp, bend, crease or load
up with paint.



Virtually Indestructible Poly Vinyl Stencils are
designed for the heaviest use, misuse, and abuse.
With minimum care, they will last a lifetime.



Variety of Products
Custom Orders

We make your job easier.

— SAVE —

- **TIME**
- **MONEY**
- **CLEAN UP**

NEW PRODUCTS



ITEM# 222 2 PIECE

**48" HIGH
LETTERS**



ITEM# 223



ITEM# 224

**1 PIECE
& 2 PIECE
STENCILS**

**Made on
Durable
1/8" Poly
Material**

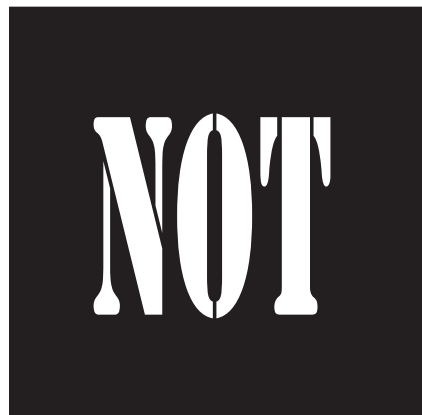

ITEM# 225



ITEM# 226

**Legends
48" High
Letters**



ITEM #227A 2 PIECE



ITEM #217A



ITEM #217B 2 PIECE



ITEM# 217



ITEM# 218

**48" HIGH
LETTERS**

**Made on
Durable
1/8" Poly
Material**



ITEM# 219 2 PIECE



ITEM# 220



ITEM# 221

NEW ADA SYMBOLS

1 PIECE STENCIL



ITEM # 227B

**12"X18" SYMBOL
W/6" WORDING
MADE ON 1/8" POLY**

AMERICAN STENCIL, LLC

11 Holt Dr., Ste 111

Stony Point, NY 10980

Phone: 201-251-6460 • Fax: 201-251-6463

amstencil@yahoo.com



ITEM# 228



ITEM# 229

QUALITY PRODUCTS AND FAST SERVICE!

All our stencils will always lay flat, yet will flex to conform to any surface—smooth or rough. Apply paint with brush, roller or spray equipment. Flexible stencils will not develop a paint build up. When paint dries, it simply flakes off.

Designed for heavy use, with minimum care our stencils will last a lifetime. Unlike wood, aluminum or other stencils, our stencils will not break, bend, crease, warp or load up with paint.

All stencils are cut to give crisp, accurate markings.

Easy to Use One-Piece Stencils

ITEM #244 EXIT STENCILS
24"W x 6"H 3½" LETTERS



ITEM #244 ENTER STENCILS
24"W x 6"H 2½" LETTERS



ITEM #244 FIRST AID STENCILS
24"W x 6"H



MAKE DANGEROUS AREAS MORE VISIBLE



AMERICAN STENCIL, LLC
 11 Holt Drive, Ste 111
 Stony Point, NY 10980
 Phone: 201-251-6460 • Fax: 201-251-6463
 amstencil@yahoo.com

www.americanstencil.com / www.americanstencil.net



Manufacturers of
Form - Flex®
 The original poly-vinyl
 permanent marking stencil.



Lighter than Wood!

Easy to Transport!

Easy Clean up!